

DETAIL "A"
(SHOWN IN UP POSITION)
BEAM PERPENDICULAR TO CURTAIN.

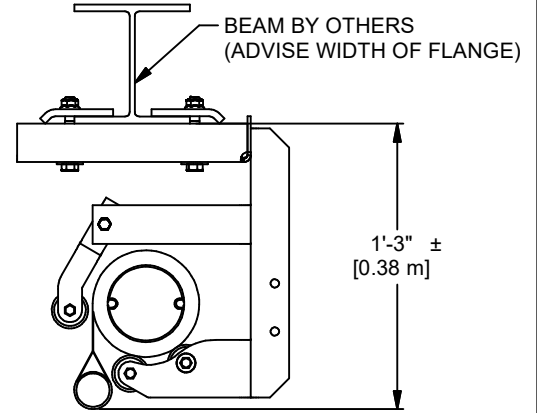

DETAIL "B"
(SHOWN IN UP POSITION)
CURTAIN DIRECTLY ATTACHED TO BEAM.
CAN ONLY BE USED WHEN BEAM IS LEVEL
WITHIN 1" IN 50 FT.

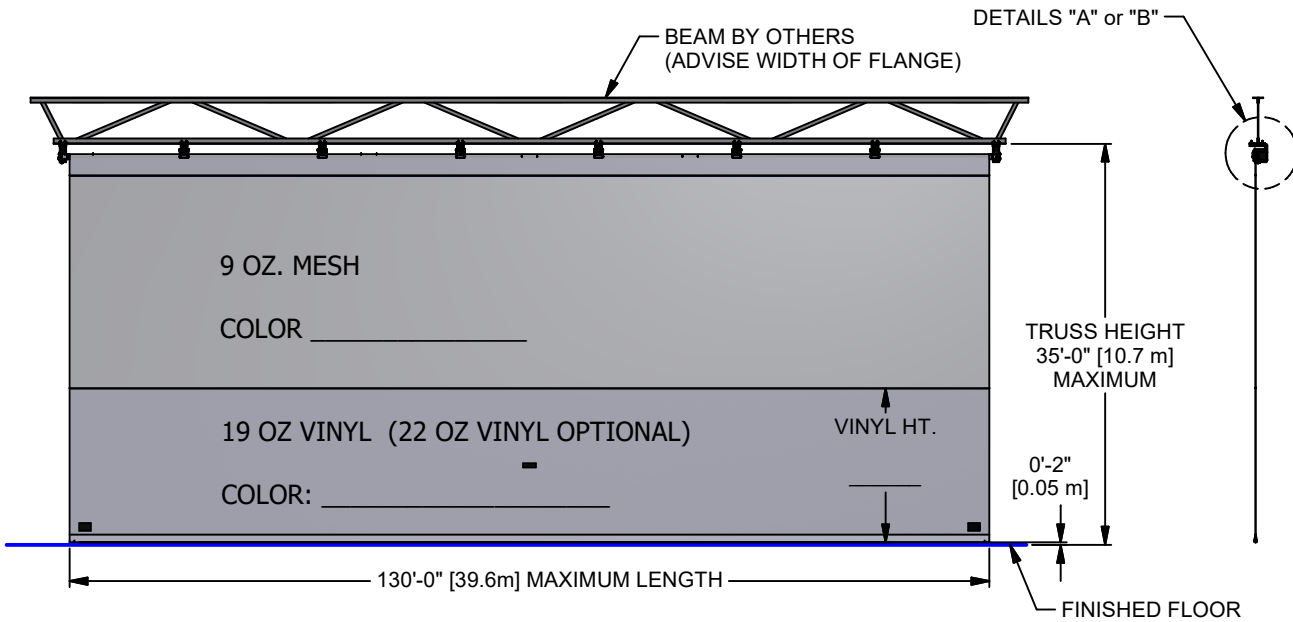

FABRIC NOTES:

- 22 OZ. VINYL ONLY AVAILABLE IN RED, ROYAL BLUE OR GRAY.

CONTROLS:

- KEY SWITCH INCLUDED. LOCATE SWITCH SO THAT OPERATOR HAS FULL VIEW OF CURTAIN AT ALL TIMES DURING OPERATION.
- SYNCHRONIZER INCLUDED WHEN (2) MOTOR ARE REQUIRED.

CONSTRUCTION:

- 4" [101.6 mm] OD ALUMINUM DRIVE TUBE
- 1.9" [48.3 mm] O.D. STEEL CARRIER ROLLERS
- 1.9" [48.3 mm] O.D. BOTTOM BATTEN TUBE
- PADDED BOTTOM BATTEN POCKET
- CURTAIN DIMENSIONS MAY BE LIMITED BY MOTOR TORQUE.

MOTOR:

- (1) or (2) TUBULAR GEARMOTORS, 1060 INLB TORQUE EACH.
- 115VAC 1PH 60HZ 4.3A or 230VAC 1PH 50HZ 2.0A (each mtr).
- WITH BRAKE AND INTEGRAL LIMIT SWITCHES.
- WITH THERMAL OVERLOAD PROTECTION.

F	MJP	01-10-23
E	WDC	11-03-21
D	WDC	02-07-20
C	WDC	12-08-17
B	WDC	08-25-16
A	WDC	01-06-16
REV	BY	DATE



Gared Holdings, LLC
9200 E. 146th St. Noblesville, IN 46060

THIS DOCUMENT CONTAINS TRADE SECRET AND OTHER MATERIALS WHICH ARE PROTECTED BY CONFIDENTIALITY NOTICE AND AGREEMENT AND BY COPYRIGHT. ANY USE OR COPYING OF THIS DOCUMENT EXCEPT AS AUTHORIZED BY GARED HOLDINGS, LLC IS STRICTLY PROHIBITED.

4040XL TOP ROLL DIVIDER CURTAIN

DRAWN	CROSBY	DATE	1/6/2016	DATE ISSUED
APPROVED		DATE		
FILE LOC. Q:\Inventor Files\Specification Files\10_Curtains				
SIZE	SCALE	SHT. NO.	PART NO.	REV
A		1 OF 5	4040	F



MODEL 4040XL

TOP ROLL DIVIDER CURTAIN

OVERHEAD STRUCTURE

The Model 4040 divider curtain is supported from the roof structure by directly attaching to the underneath side of roof truss or by attaching to 3-1/2" O.D. horizontal and 2-3/8" O.D. vertical structural tubing supplied by PSS or Gared Sports. Maximum attachment height shall not exceed 35'. Bridge pipe may be required when truss spans exceed 14'. Superstructure shall be furnished with a black powder coat finish standard. Optional colors are available.

MATERIAL

The lower 8'0" (maximum) shall be solid 19 oz. or 22 oz. polyester reinforced, fire retardant (meeting ASTM E-84 Class A rating with 25 Flame Spread and 450 Smoke Development as well as NFPA-701) and mildew resistant vinyl fabric. Seams shall be electronically welded with a full contact weld. A padded pocket shall be formed in bottom edge of curtain to accommodate a 1.9" O.D. bottom batten. Upper portion of curtain shall be 9 oz. vinyl coated polyester mesh. A pocket of vinyl shall be formed in top edge of curtain to accommodate a 1/4" nylon cord for attachment to 4" O.D. extruded aluminum drive pipe. Curtain shall stop 2" above finished floor.

DRIVE STRUCTURE

Curtains up to 500 lbs [227 kg] (including batten weight) shall be operated by one internal tubular motor (115 volt, 60 hertz, 1 phase or 230 volt, 50 hertz, 1 phase). Curtains over 500 lbs (including batten weight) shall be operated by two synchronized internal tubular motors. Each motor has a maximum torque of 1060 inch pounds [120 Nm] with a speed of 14 rpm 60 hz or 12 rpm 50 hz. Each motor shall be equipped with integral up and down limit switches. Each asynchronous motor is maintenance free, permanently lubricated, features overheating protection and has sturdy electrical and mechanical design for long life. Motors shall feature electromagnetic disk brake for smooth and accurate stop without slippage. This feature allows full braking power in the event of power failure. Motors shall also feature three-stage planetary gear mechanism for extremely quiet and reliable use. **Curtain does not require cables, belts or straps for operation.** Curtains requiring cables, belts or straps for operation shall not be considered equal.

Drive Shaft shall be supported by a carrier assembly spaced 8 to 10 ft. center to center. Center support shall consist of a formed bracket with (2) 12" long steel rollers on which drive shaft shall rotate. Steel rollers shall have permanently lubricated bearings.

Motors shall utilize a flush mounted keyed switch to raise and lower the divider curtain. Key switch shall be located so that curtain is in full view of authorized operator at all times. Optional methods of operation include a Wireless Remote Control Operator or the TSC1500 or TSC2000 Total System Control Keypad.

All electrical components to be located in overhead superstructure with the exception of the control switch. Curtains with (all) electrical components not located in overhead superstructure shall not be considered equal.

PSS or Gared Sports provides one (1) or two (2) motors with 6' cord(s), one (1) synchronizer control (when required), and one (1) key switch. Junction boxes shall be mounted within 6' of each motor. Electrical wiring for curtain must be on a dedicated circuit. **All other electrical, junction and synchronizer boxes to be furnished and installed by a certified electrical contractor. Follow manufacturer's instructions and all local codes.**

Subject to design change and current manufacturing practices.
©2008 Gared Holdings, LLC

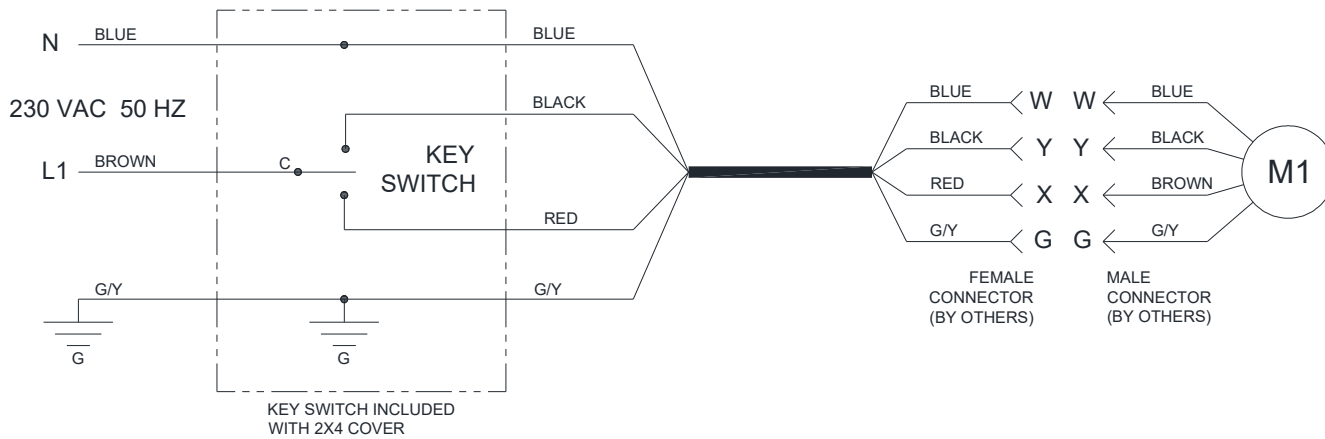
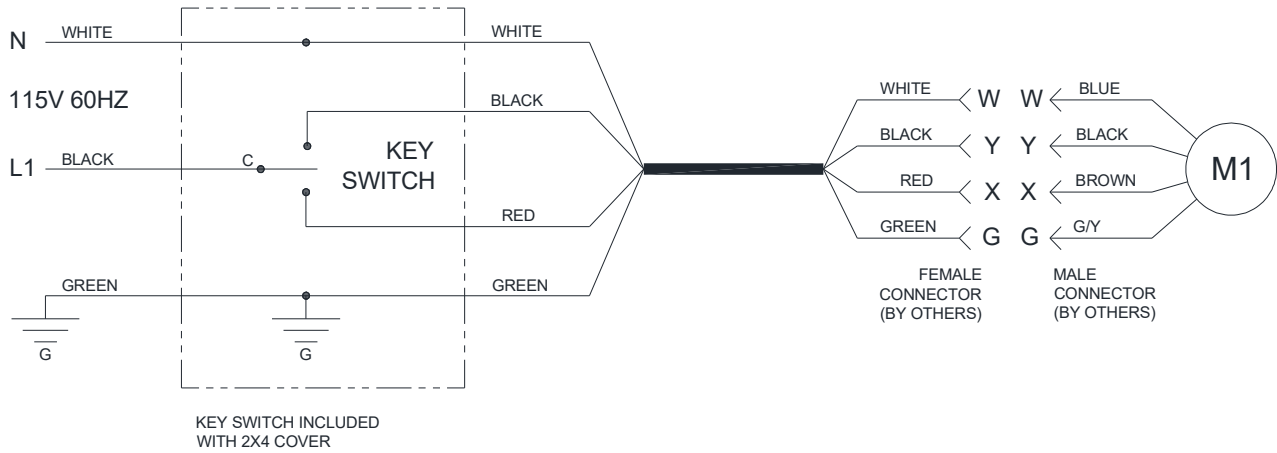

WIRING INFORMATION:

PROVIDED WITH (1) MOTOR W/ 6 FT OF CORD AND (1) KEYSWITCH.

ALL WIRING SUPPLIED BY OTHERS.

ALL OTHER ELECTRICAL AND JUNCTION, BOXES ARE TO BE FURNISHED AND INSTALLED BY A CERTIFIED ELECTRICAL CONTRACTOR, FOLLOWING ALL LOCAL CODES AND MANUFACTURE'S INSTRUCTIONS.

MOUNT JUNCTION BOXES WITHIN 6 FT. OF EACH MOTOR

ELECTRICAL WIRING FOR EACH CURTAIN MUST BE ON A DEDICATED ELECTRICAL CIRCUIT.

ELECTRICAL SPECIFICATIONS:

- DEDICATED 10A CIRCUIT BREAKER (by others)
- MOTOR: 115VAC +/- 10%, 1 PH, 60 HZ, 4.3A
- MOTOR: 230VAC +/- 10%, 1 PH, 50 HZ, 2.0A

MINIMUM KEY SWITCH BOX SIZE:

3" TALL x 2 1/4" W x 2 1/2" DEEP

F	MJP	01-10-23
E	WDC	11-03-21
D	WDC	02-07-20
C	WDC	12-08-17
B	WDC	08-25-16
A	WDC	01-06-16
REV	BY	DATE

Gared Holdings, LLC
9200 E. 146th St. Noblesville, IN 46060

THIS DOCUMENT CONTAINS TRADE SECRET AND OTHER MATERIALS WHICH ARE PROTECTED BY CONFIDENTIALITY NOTICE AND AGREEMENT AND BY COPYRIGHT. ANY USE OR COPYING OF THIS DOCUMENT EXCEPT AS AUTHORIZED BY GARED HOLDINGS, LLC IS STRICTLY PROHIBITED.

4040XL SCHEMATIC, SINGLE MOTOR

DRAWN	CROSBY	DATE	1/6/2016	DATE ISSUED
APPROVED		DATE		

FILE LOC. Q:\Inventor Files\Specification Files\10_Curtains

SIZE	SCALE	SHT. NO.	PART NO.	REV
A		3 OF 5	4040	F

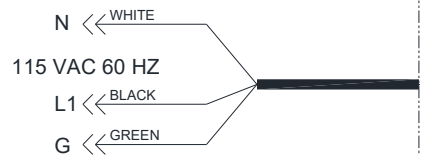

INCLUDES L5-15 PLUG W/ 6 FT POWER CORD
INCLUDES L5-15 RECEPTACLE AND 4X4 COVER

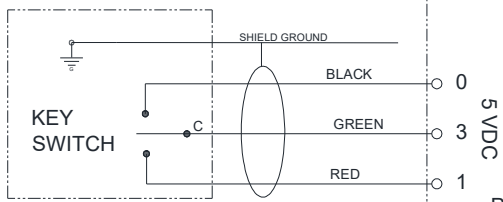

KEY SWITCH INCLUDED.
CUSTOMER SUPPLIED SHIELDED
WIRE. (Do not run with or near AC
power wires or devices)

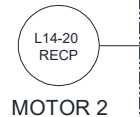
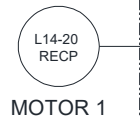

PN 701705282
SYNCHRONIZER MOTOR
CONTROL 115 VAC 1 PH

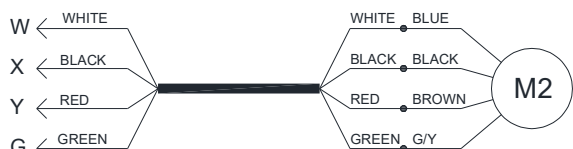
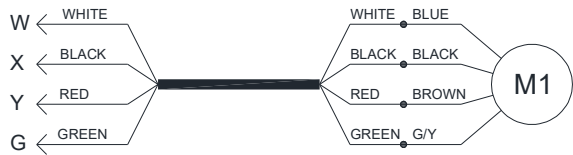

NOTE: MOTORS MUST ROTATE IN OPPOSITE
DIRECTIONS. POLARITY HAS BEEN REVERSED
IN THE SYNCHRONIZER.

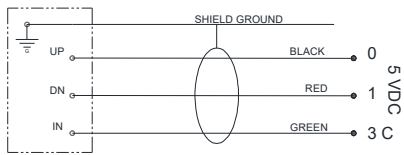

TSC1500 RELAY PANEL

WITH TSC1500 / X / XL WIFI OPTION
USED IN PLACE OF KEY SWITCH

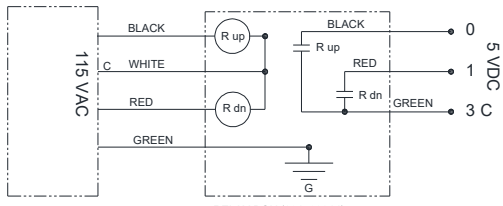
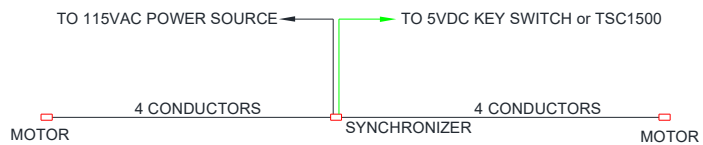

TSC2000 RELAY PANEL

RELAY BOX (801703914)
115 VAC COIL
(Locate close to Synchronizer Control)

WITH TSC2000 / X / XL OPTION.
USED IN PLACE OF KEY SWITCH

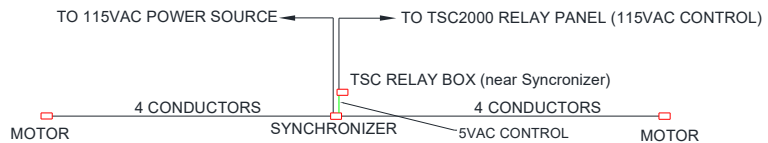

WIRING INFORMATION:

PROVIDED WITH (2) MOTORS W/ 6 FT OF CORD EACH,
(1) SYNCHRONIZER CONTROL, AND (1) KEYSWITCH.

ALL WIRING (BY OTHERS) MUST BE SUPPLIED TO
BOTH MOTORS AT EACH END OF CURTAIN FROM
SYNCHRONIZER UNITS.

ALL OTHER ELECTRICAL, JUNCTION, AND SYNCHRONIZER
BOXES ARE TO BE FURNISHED AND INSTALLED BY A
CERTIFIED ELECTRICAL CONTRACTOR, FOLLOWING
ALL LOCAL CODES AND MANUFACTURE'S INSTRUCTIONS.

MOUNT JUNCTION BOXES WITHIN 6 FT. OF EACH MOTOR

ELECTRICAL WIRING FOR EACH CURTAIN MUST BE ON A
DEDICATED ELECTRICAL CIRCUIT.

ELECTRICAL SPECIFICATIONS:

- DEDICATED 15A CIRCUIT BREAKER (by others)
- MOTOR: 115VAC +/- 10%, 1 PH, 60 HZ, 8.6 A (4.3 A per motor)

SYNCHRONIZER BOX:
7 1/2" L x 4" W x 3" DEEP

MINIMUM KEY SWITCH BOX SIZE:
3" TALL x 2 1/4" W x 2 1/2" DEEP

F	MJP	01-10-23
E	WDC	11-03-21
D	WDC	02-07-20
C	WDC	12-08-17
B	WDC	08-25-16
A	WDC	01-06-16
REV	BY	DATE

Gared Holdings, LLC
9200 E. 146th St. Noblesville, IN 46060

THIS DOCUMENT CONTAINS TRADE SECRET AND OTHER MATERIALS WHICH ARE PROTECTED BY CONFIDENTIALITY NOTICE AND AGREEMENT AND BY COPYRIGHT. ANY USE OR COPYING OF THIS DOCUMENT EXCEPT AS AUTHORIZED BY GARED HOLDINGS, LLC IS STRICTLY PROHIBITED.

4040XL SCHEMATIC, DUAL 115V 1PH 60HZ

DRAWN	CROSBY	DATE	1/6/2016	DATE ISSUED
APPROVED		DATE		
FILE LOC. Q:\Inventor Files\Specification Files\10_Curtains				
SIZE	SCALE	SHT. NO.	PART NO.	REV
A		4 OF 5	4040	F

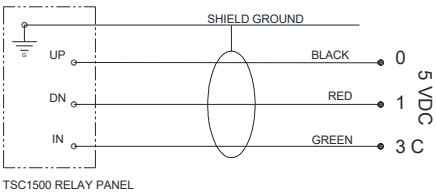
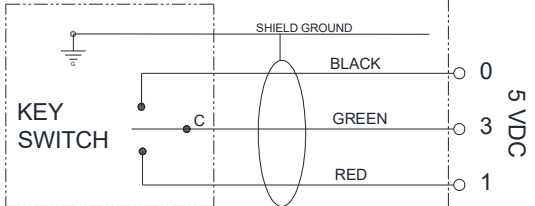
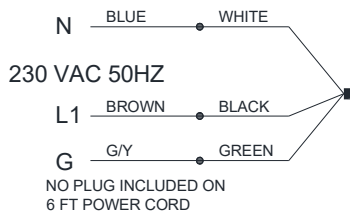

WITH TSC1500 / X / XL WIFI OPTION USED IN PLACE OF KEY SWITCH

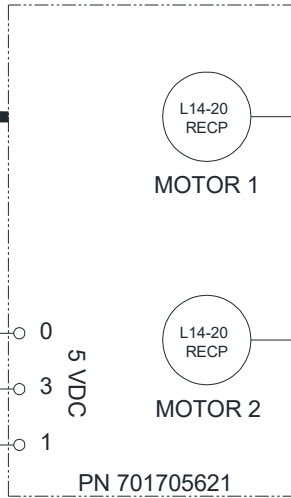

SYNCHRONIZER MOTOR CONTROL 230 VAC 1 PH

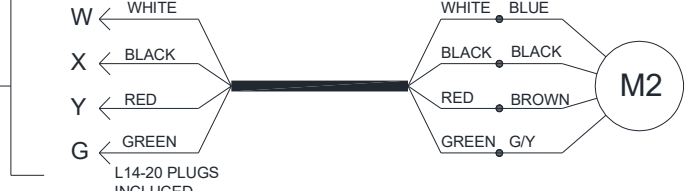
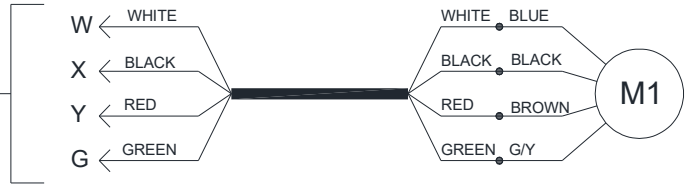

NOTE: MOTORS MUST ROTATE IN OPPOSITE DIRECTIONS. POLARITY HAS BEEN REVERSED IN THE SYNCHRONIZER.

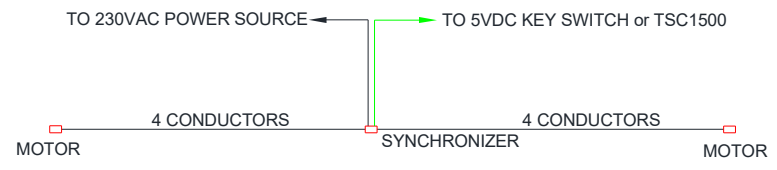

WIRING INFORMATION:

PROVIDED WITH (2) MOTORS W/ 6 FT OF CORD EACH, (1) SYNCHRONIZER CONTROL, AND (1) KEYSWITCH.

ALL WIRING (BY OTHERS) MUST BE SUPPLIED TO BOTH MOTORS AT EACH END OF CURTAIN FROM SYNCHRONIZER UNITS.

ALL OTHER ELECTRICAL, JUNCTION, AND SYNCHRONIZER BOXES ARE TO BE FURNISHED AND INSTALLED BY A CERTIFIED ELECTRICAL CONTRACTOR, FOLLOWING ALL LOCAL CODES AND MANUFACTURE'S INSTRUCTIONS.

MOUNT JUNCTION BOXES WITHIN 6 FT. OF EACH MOTOR

ELECTRICAL WIRING FOR CURTAIN MUST BE ON A DEDICATED ELECTRICAL CIRCUIT.

ELECTRICAL SPECIFICATIONS:

- DEDICATED 10A CIRCUIT BREAKER (by others)
- MOTOR: 230VAC +/- 10%, 1 PH, 50 HZ, 4.0 A (2.0 A per motor)

SYNCHRONIZER BOX:

7 1/2" L x 4" W x 3" DEEP

MINIMUM KEY SWITCH BOX SIZE:

3" TALL x 2 1/4" W x 2 1/2" DEEP

F	MJP	01-10-23
E	WDC	11-03-21
D	WDC	02-07-20
C	WDC	12-08-17
B	WDC	08-25-16
A	WDC	01-06-16
REV	BY	DATE

THIS DOCUMENT CONTAINS TRADE SECRET AND OTHER MATERIALS WHICH ARE PROTECTED BY CONFIDENTIALITY NOTICE AND AGREEMENT AND BY COPYRIGHT. ANY USE OR COPYING OF THIS DOCUMENT EXCEPT AS AUTHORIZED BY GARED HOLDINGS, LLC IS STRICTLY PROHIBITED.

4040XL SCHEMATIC, DUAL 230V 1PH 50HZ

DRAWN	CROSBY	DATE	1/6/2016	DATE ISSUED
APPROVED		DATE		
FILE LOC. Q:\Inventor Files\Specification Files\10_Curtains				
SIZE	SCALE	SHT. NO.	PART NO.	REV
A		5 OF 5	4040	F