

NOTE:

GOAL TESTED TO 1000 LBS. STATIC LOAD WHILE ATTACHED TO A SOLID COLUMN.

GARED HOLDINGS, LLC DOES NOT RECOMMEND HANGING FROM RIM OR SUSPENDING WEIGHTS FROM RIM.

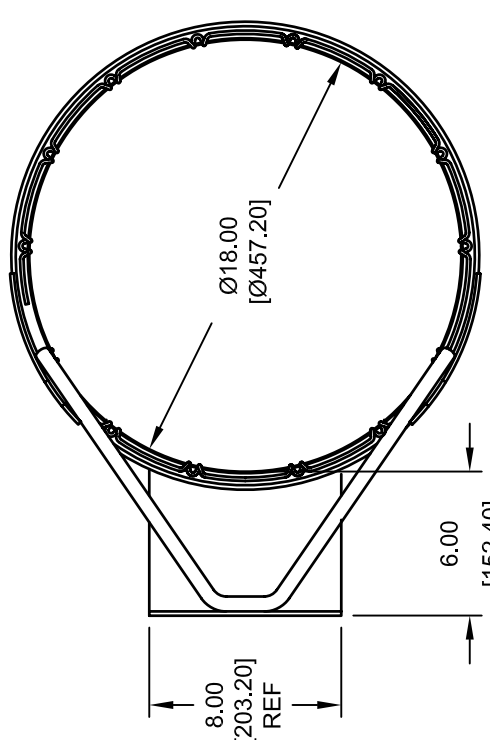

(BOTTOM VIEW)

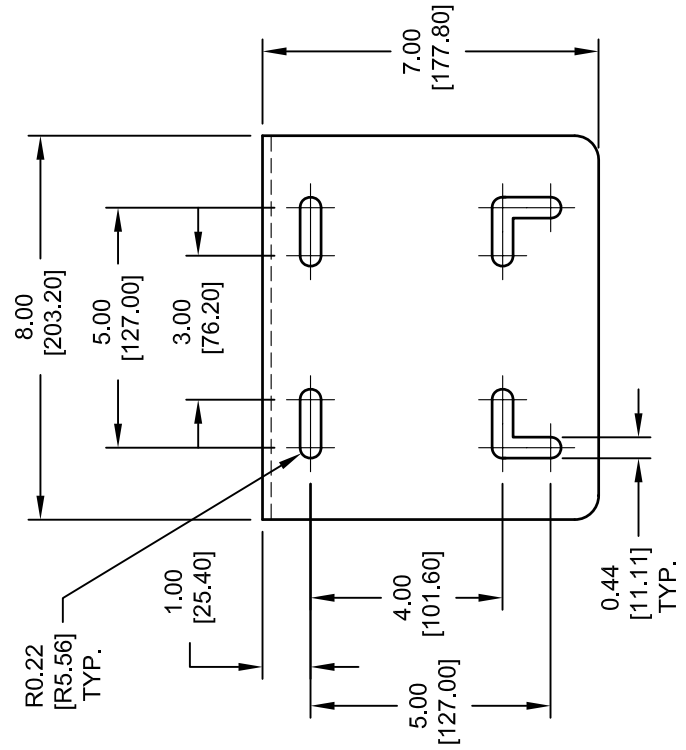

NOTE: FINISH - OFFICIAL ORANGE POWDER COAT. GOAL IS SUPPLIED WITH NYLON NET AND HARDWARE.

MOUNTING PLATE VIEW
SCALE 2:1

REVISION		
REV.	DATE	BY
A	12/20/06	WAE
B	04/22/08	RWP



Gared Holdings, LLC
9200 E. 146th St. Noblesville, IN 46060

THIS DOCUMENT CONTAINS TRADE SECRET AND OTHER MATERIALS WHICH ARE PROTECTED BY CONFIDENTIALITY NOTICE AND AGREEMENT AND BY COPYRIGHT. ANY USE OR COPYING OF THIS DOCUMENT EXCEPT AS AUTHORIZED BY GARED HOLDINGS, LLC IS STRICTLY PROHIBITED.

TITAN PLAYGROUND SUPER GOAL				
DRAWN	CONNERLEY	DATE	12/04/03	MATERIAL AS NOTED
APPROVED	JJC	DATE	12/04/03	FINISH AS NOTED
FILE LOC. Q:\Final Release\Specifications			DWG. NO.	7550
SIZE	SCALE	SHT. NO.	PART NO.	REV
A	NONE	1 OF 1	7550	B



MODEL 7550

EXTRA HEAVY STATIONARY FRONT MOUNT GOAL (Titan Playground Super Goal)

The 7550 goal shall be constructed with an official sized 18" ring of 3/4" diameter with an additional support ring of 5/8" diameter. A continuous no-tie ring with twelve net holders shall be welded to the lower support ring. Goal shall be made with high carbon/manganese materials for high strength. Back plate shall be 3/16" thick and 8" wide x 7" long. Brace shall be 5/8" diameter all welded construction and connected to the goal ring with the addition of a 3/16" thick web plate.

Goal shall have a durable orange powder coated finish and come complete with nylon net and zinc plated mounting hardware. Universal goal mounting plate will fit hole patterns for most 42", 48", and fan-shaped backboards.

ACCESSORIES

BACKBOARDS

Compatible backboards are models 1301B, 1342B, 1370B, 1245T, 1270B, 1272B, 1401B, 1442B, 1750B, BB60A38, BB60G38, BB72A38, BB72G50, RG, AFRG48, and FSGII. See backboard section in specification manual.